



深圳市谷林动力科技有限公司

SHENZHEN GULIN POWER TECHNOLOGY CO.,LTD

谷林动力(东莞)科技有限公司

GULIN POWER (DONGGUAN) TECHNOLOGY CO., LTD

电话/Tel: +86 755 2101 3879

传真/Fax: +86 755 2101 3879

邮箱/E-mail: Sales@igulen.com

官网/Web: www.igulen.com

深圳办公室地址: 广东省深圳市龙华区龙华街道人民路环智中心B座1302室

Shenzhen office address: Room 1302, Block B, Huanzhi Center, Renmin Road,
Longhua Street, Longhua New District, Shenzhen ,China

东莞工厂地址: 广东省东莞市大朗镇松木山祥荣路23号

Dongguan factory address: No. 23, Xiangrong Road, Songmu Mountain,
Dalang Town, Dongguan, China



CAR AIR PUMP

WIRELESS VACUUM CLEANER

HIGH PRESSURE CAR WASHER

Shenzhen Gulin Power Technology Co., Ltd was founded in 2014, which is a technological innovation-based enterprise combining the R&D, manufacture and marketing of automotive electronic series products. We have about 100 employees and cover an area of 3000 square meters. All products are with appearance patents & some with technology patents and have been certified by CE, RoHS and FCC. Our products are exported to America, Japan, Australia, Sweden, UK and more than 40 countries.

We have attained the ISO 9001:2015 quality management system certification and ISO 14001:2015 environmental management system certification. Also, we have powerful technology research strength and a comprehensive quality management system, and have already formed a complete product chain for OEMs and can provide more professional ODM project management.

- 2014 Establish Gulin company
- 2015 Attend Frankfurt show(Shanghai)
- 2016 Establish Taiwan R&D center and attend Frankfurt show(Germany)
- 2017 Attend SEMA show(Las Vegas)
- 2018 R&D car vacuum cleaner and applied for all related patents and certifications
- 2019 Mass production of car vacuum cleaner
- 2020 R&D and mass production of car air pump
- 2021 Awarded "National High-tech Enterprise"
- 2022 R&D and mass production of high pressure car washer
Awarded "Shenzhen Innovative SMEs"
- 2023 Awarded "Shenzhen Specialized and Sophisticated SMEs"

We insist on taking the customer demand as the center and technological innovation as the root, keep providing competitive and valuable products.

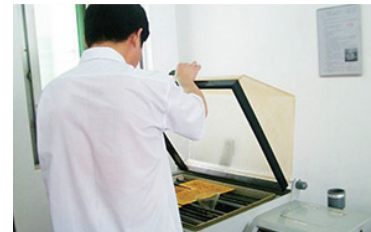

Wireless Vacuum Cleaner



● BLACK & SPACE GREY ● WHITE & SILVER

SIZE & ACCESSORIES



PRODUCT PARAMETERS

Model:	V02-2	V02H-2
Suction(High level):	5000Pa	13000Pa
Working time(High level):	18mins	19mins
Suction(Low level):	3500Pa	6500Pa
Working time(Low level):	28mins	32mins
Battery:	2000mAhx2/14.8Wh	2500mAhx2/18.5Wh
Noise:	≤75dB	≤75dB
Input:	5V---2A	5V---2A
Dust bin:	130ml	130ml

CE FC RoHS

Wireless Vacuum Cleaner



● BLACK

○ WHITE & SILVER

SIZE & ACCESSORIES

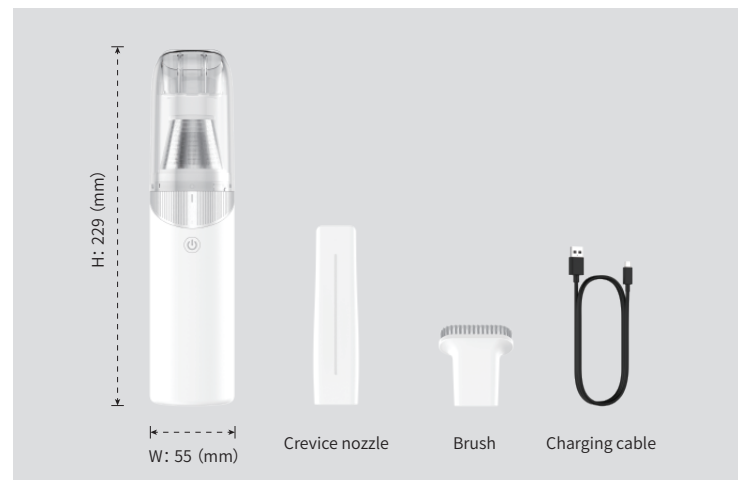

PRODUCT PARAMETERS

Model:	V03-2	V03H-2
Suction(High level):	5000Pa	13000Pa
Working time(High level):	18mins	19mins
Suction(Low level):	3500Pa	6500Pa
Working time(Low level):	28mins	32mins
Battery:	2000mAhx2/14.8Wh	2500mAhx2/18.5Wh
Noise:	≤75dB	≤75dB
Input:	5V---2A	5V---2A
Dust bin:	130ml	130ml

CE FC RoHS

Wireless Vacuum Cleaner



● BLACK & SPACE GREY ● WHITE & SILVER

SIZE & ACCESSORIES

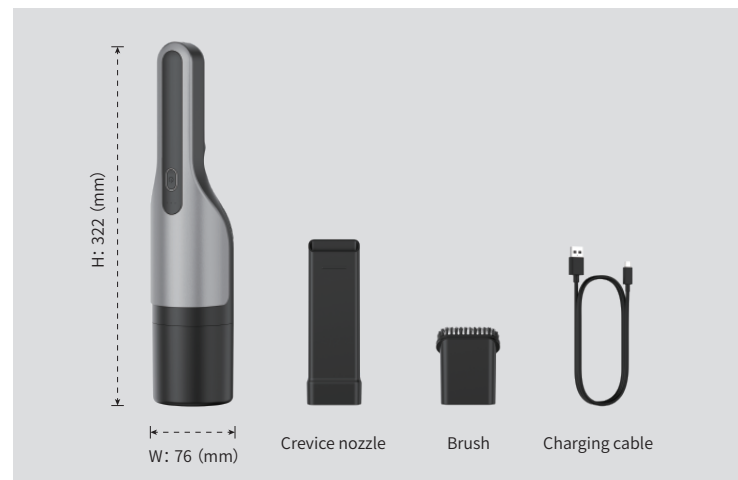

PRODUCT PARAMETERS

Model:	V05-2	V05H-2
Suction(High level):	5800Pa	13000Pa
Working time(High level):	15mins	18mins
Suction(Low level):	3500Pa	7000Pa
Working time(Low level):	25mins	30mins
Battery:	2500mAhx2/18.5Wh	2500mAhx2/18.5Wh
Noise:	≤80dB	≤75dB
Input:	5V ---2A	5V ---2A
Dust bin:	120ml	120ml

CE FC RoHS

Wireless Vacuum Cleaner



BLACK & RED

WHITE & SILVER

SIZE & ACCESSORIES



PRODUCT PARAMETERS

Model:	V07-3	V07-2	V07H-2
Suction(High level):	6500Pa	6000Pa	12500Pa
Working time(High level):	28mins	16mins	13mins
Suction(Low level):	3500Pa	4000Pa	7500Pa
Working time(Low level):	38mins	25mins	32mins
Battery:	2500mAhx3/27.75Wh	2500mAhx2/18.5Wh	2500mAhx2/18.5Wh
Noise:	≤80dB	≤80dB	≤75dB
Input:	5V ---2A	5V ---2A	5V ---2A
Dust bin:	100ml	100ml	100ml

CE FC RoHS

Wireless Vacuum Cleaner



 BLACK & RED

 WHITE & SILVER

SIZE & ACCESSORIES

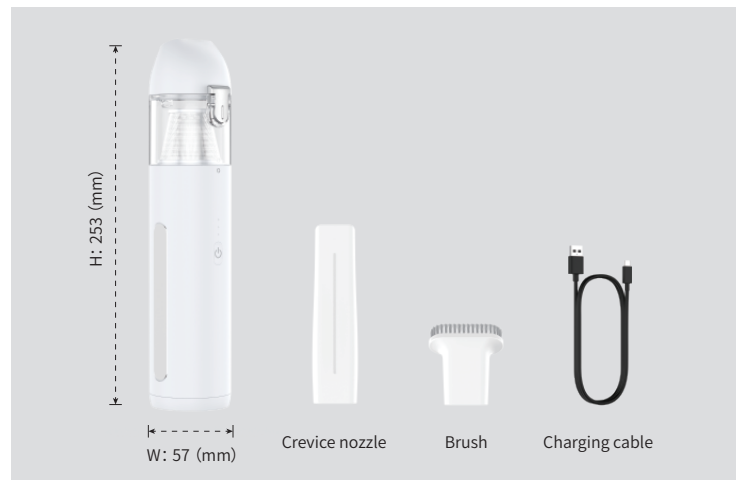

PRODUCT PARAMETERS

Model:	V08-3	V08H-2
Suction(High level):	5800Pa	12000Pa
Working time(High level):	30mins	14mins
Suction(Low level):	3000Pa	6000Pa
Working time(Low level):	45mins	26mins
Battery:	2500mAhx3/27.75Wh	2500mAhx2/18.5Wh
Noise:	≤80dB	≤80dB
Input:	5V---2A	5V---2A
Dust bin:	100ml	100ml



Wireless Vacuum Cleaner



● BLACK & SILVER

● BLACK & SPACE GREY

SIZE & ACCESSORIES

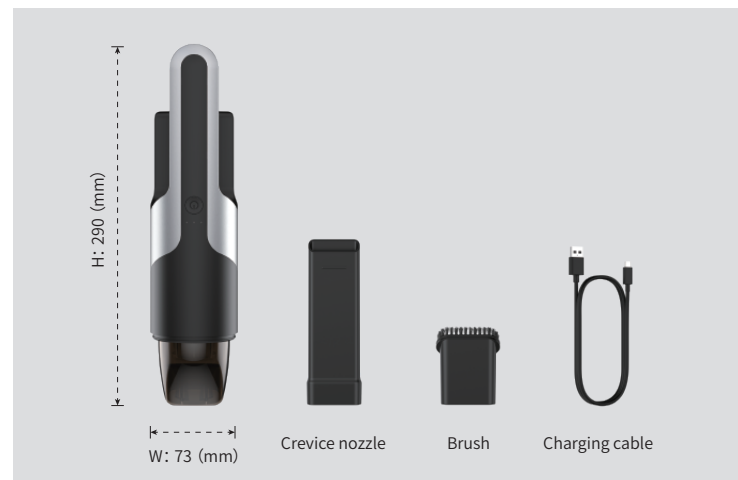

PRODUCT PARAMETERS

Model:	V09-2	V09H-2
Suction(High level):	5800Pa	13000Pa
Working time(High level):	15mins	18mins
Suction(Low level):	3500Pa	7000Pa
Working time(Low level):	25mins	30mins
Battery:	2500mAhx2/18.5Wh	2500mAhx2/18.5Wh
Noise:	≤80dB	≤75dB
Input:	5V ---2A	5V ---2A
Dust bin:	120ml	120ml

CE FC RoHS

Wireless Vacuum Cleaner



● BLACK & SPACE GREY

SIZE & ACCESSORIES



PRODUCT PARAMETERS

Model:	V10-2
Suction(High level):	5300Pa
Working time(High level):	14mins
Suction(Low level):	3500Pa
Working time(Low level):	29mins
Battery:	2500mAhx2/18.5Wh
Noise:	≤80dB
Input:	5V---2A
Dust bin:	120ml

CE FC RoHS

Wireless Vacuum Cleaner



WHITE & BLUE

WHITE & GREY

SIZE & ACCESSORIES

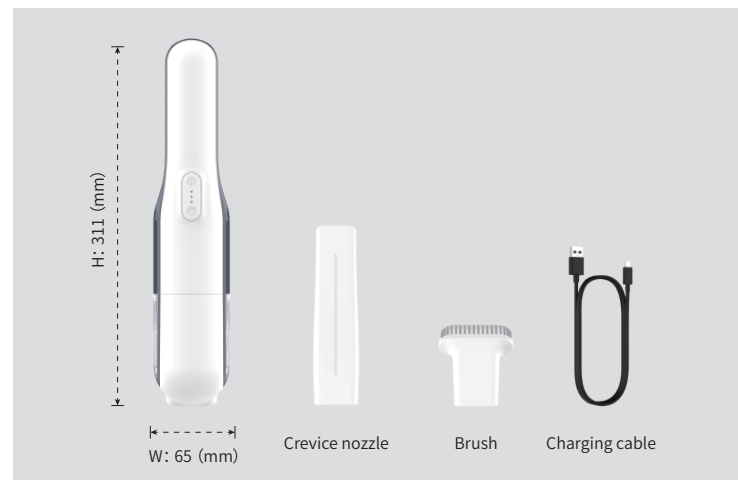

PRODUCT PARAMETERS

Model:	V12-2	V12H-3	V12H-2
Suction(High level):	6200Pa	13500Pa	13000Pa
Working time(High level):	21mins	18mins	19mins
Suction(Low level):	3100Pa	6500Pa	6000Pa
Working time(Low level):	42mins	51mins	32mins
Battery:	2500mAhx2/18.5Wh	2500mAhx3/27.75Wh	2500mAhx2/18.5Wh
Noise:	≤80dB	≤75dB	≤75dB
Input:	5V---2A	5V---2A	5V---2A
Dust bin:	150ml	150ml	150ml

CE FC RoHS

Wireless Vacuum Cleaner



● BLACK & SPACE GREY

SIZE & ACCESSORIES

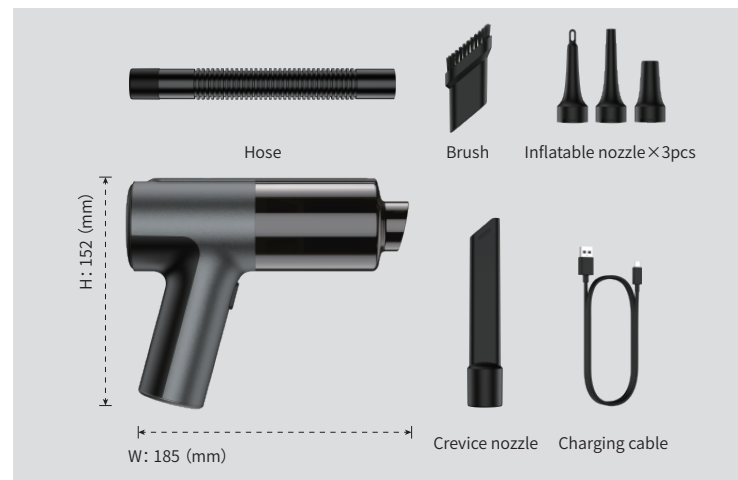

PRODUCT PARAMETERS

Model:	V15H-2	V15H-3
Suction(High level):	12000Pa	17000Pa
Working time(High level):	15mins	16mins
Suction(Low level):	6500Pa	9000Pa
Working time(Low level):	28mins	60mins
Battery:	2500mAhx2/18.5Wh	2500mAhx3/27.75Wh
Noise:	≤75dB	≤75dB
Input:	5V---2A	5V---2A
Dust bin:	130ml	130ml

CE FC RoHS

Wireless Vacuum Cleaner



● BLACK & SPACE GREY

SIZE & ACCESSORIES



PRODUCT PARAMETERS

Model:	V16H-2
Suction(High level):	11500Pa
Working time(High level):	12mins
Suction(Low level):	6400Pa
Working time(Low level):	25mins
Battery:	2500mAhx2/18.5Wh
Noise:	≤75dB
Input:	5V---2A
Dust bin:	130ml

CE FC RoHS

12V Car Air Pump



● BLACK & GREY

SIZE & ACCESSORIES



PRODUCT PARAMETERS

Model:	A3-DC
DC input:	12V --- 10A
DC cable length:	3M
Noise:	≤85dB
Working temperature:	0°C-35°C

CE FC RoHS

12V Car Air Pump

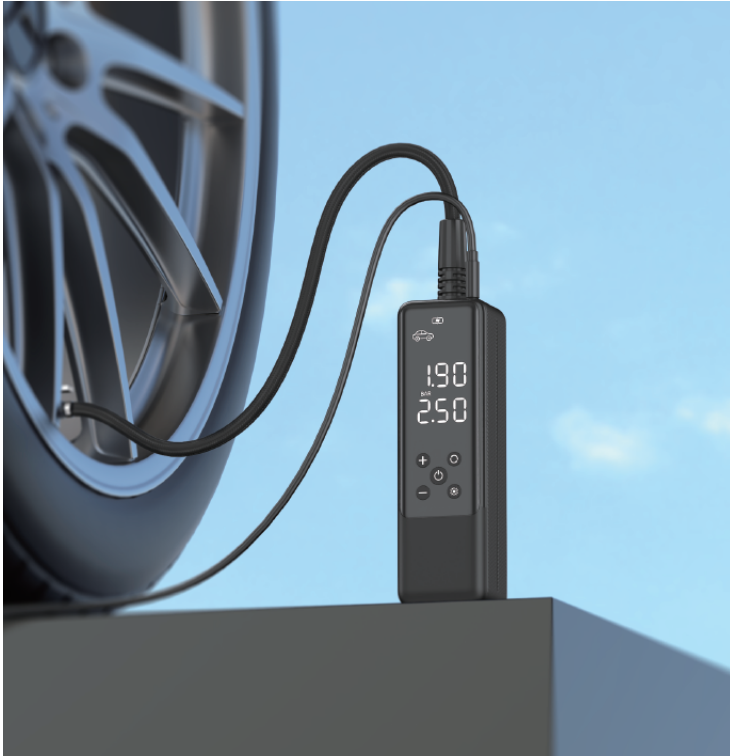

● BLACK

SIZE & ACCESSORIES

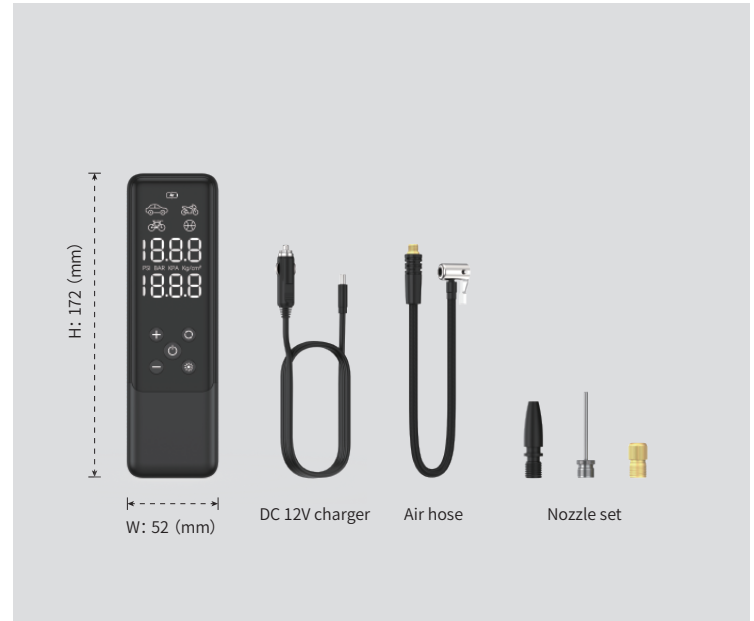

PRODUCT PARAMETERS

Model:	A5-DC
DC input:	12V --- 10A
DC cable length:	3M
Noise:	≤85dB
Working temperature:	0°C-35°C

CE FC RoHS

Wireless Car Air Pump



● BLACK & SPACE GREY

SIZE & ACCESSORIES

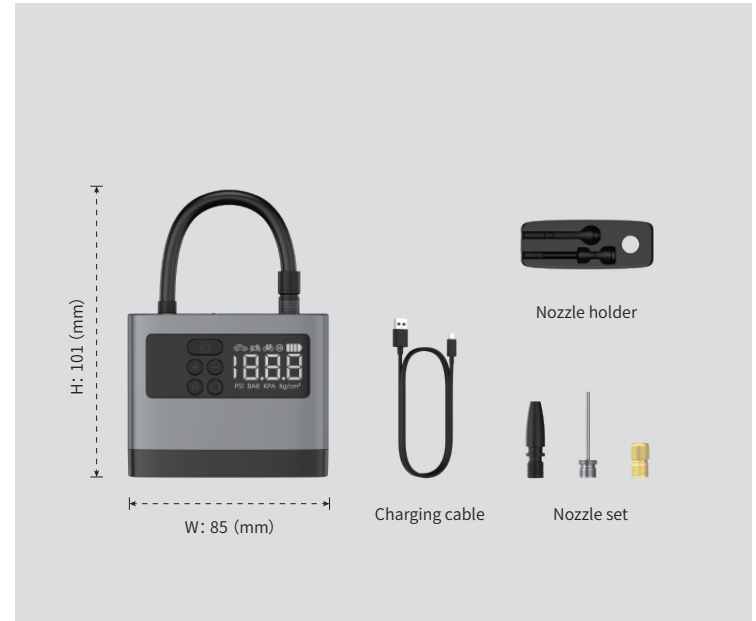

PRODUCT PARAMETERS

Model:	A6-2
Battery:	2500mAhx2/18.5Wh
Type-C input:	5V---2A
Noise:	≤85dB
Working temperature:	0°C-35°C

CE FC RoHS

Wireless Car Air Pump



● BLACK

SIZE & ACCESSORIES



PRODUCT PARAMETERS

Model:	A7-2
Battery:	2500mAhx2/18.5Wh
Type-C input:	5V---2A
Noise:	≤85dB
Working temperature:	0°C-35°C

CE FC RoHS

Wireless Car Air Pump



● BLACK

SIZE & ACCESSORIES

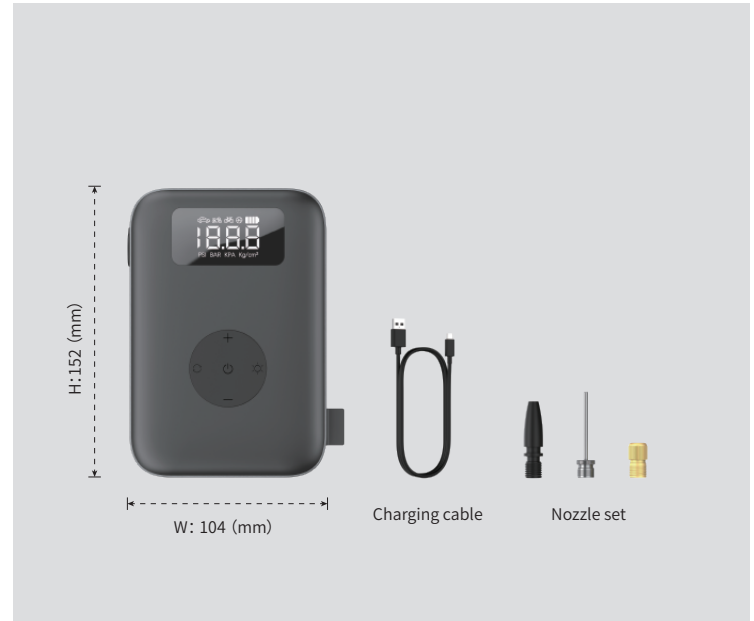

PRODUCT PARAMETERS

Model:	A8-2
Battery:	2500mAhx2/18.5Wh
Type-C input:	5V---2A
Noise:	≤85dB
Working temperature:	0°C-35°C

CE FC RoHS

Wireless Car Air Pump



● BLACK

SIZE & ACCESSORIES

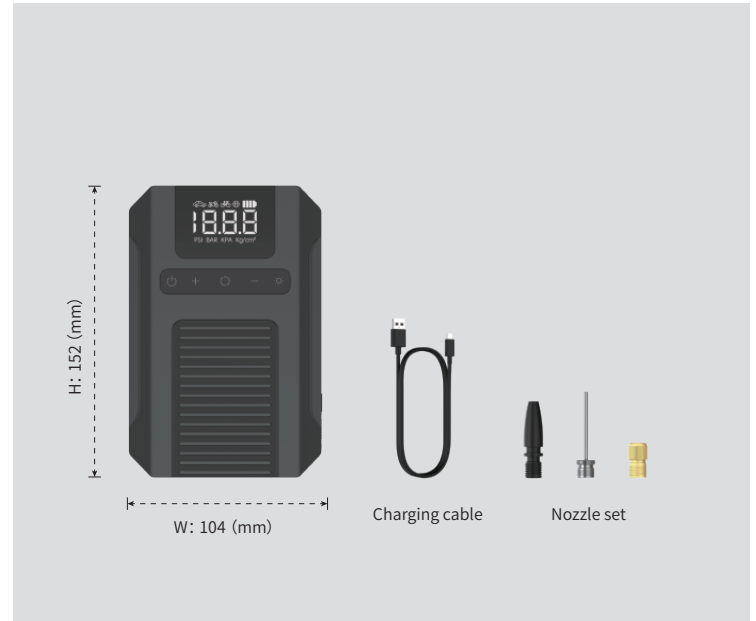

PRODUCT PARAMETERS

Model:	A9-2
Battery:	2500mAhx2/18.5Wh
Type-C input:	5V---2A
Noise:	≤85dB
Working temperature:	0°C-35°C

CE FC RoHS

Portable Car Air Pump



● BLACK

SIZE & ACCESSORIES



PRODUCT PARAMETERS

Model:	A10-3DC (2 IN 1)	A10-2 (Wireless)
Battery:	2500mAhx3/27.75Wh	2500mAhx2/18.5Wh
Type-C input:	5V---2A	5V---2A
USB output:	5V---2.1A	5V---2.1A
DC input:	12V---10A	---
DC cable length:	3M	---
Noise:	≤85dB	≤85dB
Working temperature:	0°C-35°C	0°C-35°C

CE FC RoHS

Portable Car Air Pump



● BLACK

SIZE & ACCESSORIES



PRODUCT PARAMETERS

Model:	A12-3DC (2 IN 1)	A12-2 (Wireless)
Battery:	2500mAhx3/27.75Wh	2500mAhx2/18.5Wh
Type-C input:	5V---2A	5V---2A
USB output:	5V---2.1A	5V---2.1A
DC input:	12V---10A	---
DC cable length:	3M	---
Noise:	≤85dB	≤85dB
Working temperature:	0°C-35°C	0°C-35°C

CE FC RoHS

Portable Car Air Pump



● BLACK

SIZE & ACCESSORIES

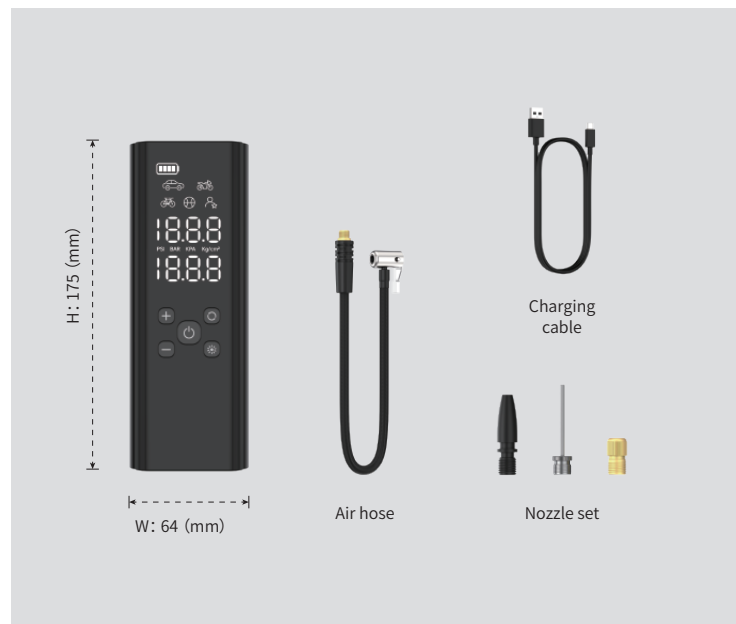

PRODUCT PARAMETERS

Model:	A13-3 (Wireless)
Battery:	2500mAhx3/27.75Wh
Type-C input:	5V---2A
USB output:	5V---2.1A
Noise:	≤85dB
Working temperature:	0°C-35°C

CE FC RoHS

12V Car Air Pump



● BLACK & GREY

SIZE & ACCESSORIES

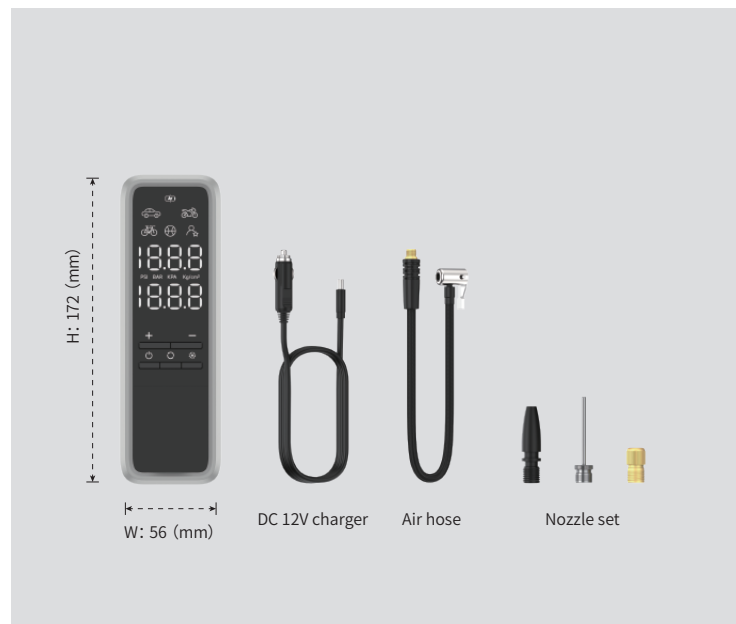

PRODUCT PARAMETERS

Model:	A15-DC
DC input:	12V --- 10A
DC cable length:	3M
Noise:	≤85dB
Working temperature:	0°C-35°C

CE FC RoHS

Portable Car Air Pump



● BLACK & GREY

SIZE & ACCESSORIES



PRODUCT PARAMETERS

Model:	A16-3DC (2 IN 1)	A16-2 (Wireless)
Battery:	2500mAhx3/27.75Wh	2500mAhx2/18.5Wh
Type-C input:	5V---2A	5V---2A
USB output:	5V---2.1A	5V---2.1A
DC input:	12V---10A	---
DC cable length:	3M	---
Noise:	≤85dB	≤85dB
Working temperature:	0°C-35°C	0°C-35°C

CE FC RoHS

Portable Car Air Pump



● BLACK

SIZE & ACCESSORIES



PRODUCT PARAMETERS

Model:	A18-3DC (2 IN 1)	A18-2 (Wireless)
Battery:	2500mAhx3/27.75Wh	2500mAhx2/18.5Wh
Type-C input:	5V---2A	5V---2A
USB output:	5V---2.1A	5V---2.1A
DC input:	12V---10A	---
DC cable length:	3M	---
Noise:	≤85dB	≤85dB
Working temperature:	0°C-35°C	0°C-35°C

CE FC RoHS

2 IN 1

Air Pump + Jump Starter



● BLACK & SPACE GREY

SIZE & ACCESSORIES

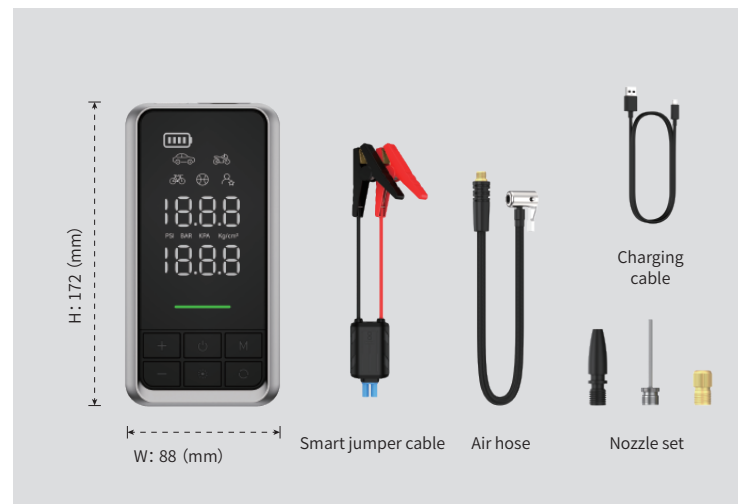

PRODUCT PARAMETERS

Model:	AS09
Battery:	2600mAhx4/38.48Wh
Type-C input:	5V---2A
USB output:	5V---2.1A
Starting current:	500A
Peak current:	1200A
Noise:	≤85dB
Working temperature:	0°C-35°C

CE FC RoHS

Portable Air Duster



● BLACK & SILVER

SIZE & ACCESSORIES



PRODUCT PARAMETERS

Model:	D09H-2
Battery:	2500mAhx2/18.5Wh
Type-C input:	5V---2A
Power:	90W
Noise:	≤85dB

CE FC RoHS

2 in 1 High Pressure Car Washer



WHITE & BLUE

WHITE & GREY

SIZE & ACCESSORIES

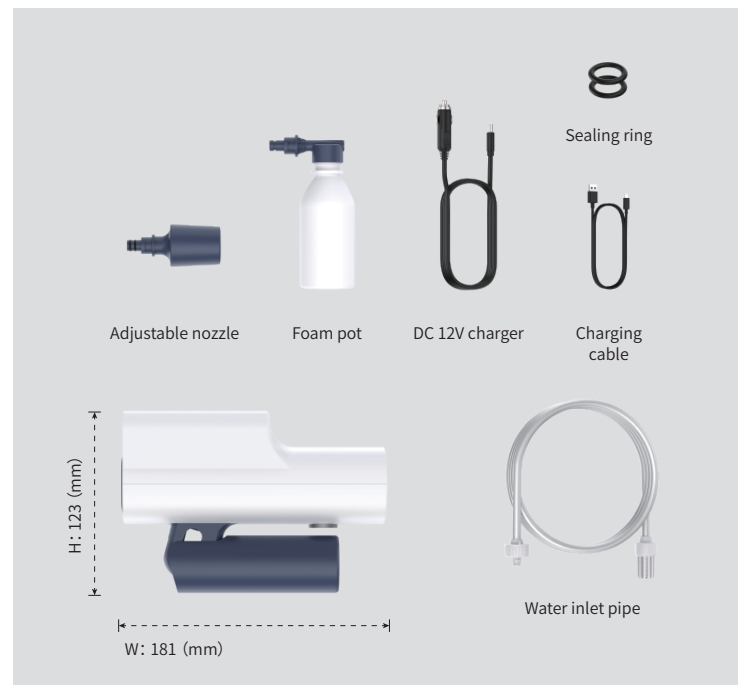

PRODUCT PARAMETERS

Model: H7-3DC	
Type-C input: 5V ---2A	DC input: 12V ---10A
Peak pressure: 1.7Mpa	Working time: 30mins
Battery: 4000mAhx3/43.2Wh	Length of water pipe: 5M
Spraying way: high-pressure type & normal type & 25° fan type & 40° fan type & watering type	

CE FC RoHS

Portable High Pressure Car Washer



● BLACK & ORANGE

● BLACK & GREEN

SIZE & ACCESSORIES



PRODUCT PARAMETERS

Model: H9-3	
Battery: 5000mAhx3/55.5Wh	Type-C input: 5V---2A
Peak pressure: 1.7Mpa	Working time: 25mins
Spraying way: direct type & fan type & atomized type	Length of water pipe: 5M

CE FC RoHS